

LOTHAR WALTHER



gun barrels and more



brochure Europe

LOTHAR WALTHER
Feinwerkzeugbau GmbH
Paul Reusch Straße 34
89551 Königsbronn
Germany

Phone ++49(0)7328-96300
Fax ++49(0)7328-5066
email: info@lothar-walther.de
<http://www.lothar-walther.de>

Lothar Walther, engineer, founded the company **LOTHAR WALTHER** on 1.7.1925 in Zella Mehlis Thuringen. As the youngest son of Carl Walther, the founder of the world-famous gun factory, he grew up in a family which had been steeped in weapons manufacture for generations.

At that time, the towns of Zella-Mehlis and Suhl were the centres of the German gun industry.

The experience gained over many years of gun manufacture provided Lothar Walther with special expertise in the production of button-rifled barrels of the highest accuracy.

As a member of the German National Pistol Team, Lothar Walther won many German Championships and the bronze medal at the 1939 World Championships. Having always competed at the highest levels in international target shooting he had an intimate knowledge of the requirements of shooters.

After the Second World War and the associated move to Baden-Württemberg, Lothar Walther once again chanced a new start. From the beginning of the 60s he was supported in this by his sons. Klaus Walther, trained precision mechanic and master toolmaker, sports marksman and impassioned huntsman, he ran the company up to 1996. During this time, the company was transformed from a craftsman's workshop into an internationally-oriented company with the most modern machinery and well-trained expert staff.



Lothar Walther 1899 - 1983

Equipped with the latest technical machinery, **LOTHAR WALTHER** currently manufactures

- button-rifled barrels
from special gun steel and stainless steel, in more than 240 different calibres for target shooting, hunting, muzzle-loading and air guns.

These barrels are made for the whole spectrum of shooting, encompassing shooters with modest requirements right through to those who wish to compete at the highest international level.

The production programme also includes:

- bawel adapters for both hunting and practising with pistols, revolvers, rifles and shotguns,
- combined spirit-level foresights,
- cartridge adapters, snapcaps
- Adapters for shotguns
- inspection lamps to examine gun barrels an cativites in general,
- target crossbows.

**World Champions
shoot with
LOTHAR WALTHER
gun barrels!**



table of contents

LOTHAR WALTHER	„the history“	2
	„the factory“	3
	5
News		
barrel blanks		
spec. rifle steel	metric	4 mm M 20 to 6,5 x 68..... 6
		7,65 mm to 9 mm short..... 7
		9 mm Para to 12,7 x 70 Schüler 8
	inch	.17 Rem. to .22 l.r..... 8
		.22 Mag. to .30 Carbine 9
		.32 S & W to .585 Nyatti 10
stainless steel	metric	5,6 x 50 Mag. to 10 mm Auto . 11
	inch	.17 Rem.. to .338 Win.Mag..... 11
		.38 Spec./ to .50 BMG 12
black powder		.31 to .58..... 12
air gun		4,5 mm (.177) to 6,35 mm (.25) 13
polygon profile		.223 Rem to .45 ACP 13
custom made		
barrel blanks and options	(contours, threads etc.)	14-16
barrels finished in the white		
for Mauser 98 action	(hunting contours)	17
octagonal milled	18
for combined guns	18
original Mauser shapes (type 88,96,98,Argentino,etc.)....		18-19
LOTHAR WALTHER - match barrels		19
Big bull	19
rifle barrel® finished for AR 15 sporting rifle		19
Ruger 10/22 Target barrel	19
for Luger 08 pistol	20
match barrel finishes for M1-Garand		20
barrel blank for shotgun / turned		20
additional services	21
Small Bore Practice Target		21
barrel warranty, safety instructions		21
barrel / adapters		
for revolver and pistols (shoot 4 mm M 20 to .22 l.r.) ...		22-23
for rifles and shotguns (shoot 4 mm M 20 to .45 Colt).		24-25
for shotguns (shoot 6 mm shot to 16 gauge shot).....		25-27
accessories		
training targets	21/29
dummy cartridge	27
muzzle brakes	28
snap caps for shotgun, rifle, pistol and revolver		28
salut adapter for shotgun	29
combined spirit level foresight.....		29
inspection lamp	29
crossbow		
crossbow „Hobby Tell 2“		30
crossbow „Hobby Tell SPORT“		31

New Calibres:

6XC	barrel blank / special rifle steel	page 6
6XC	barrel blank / stainless steel.....	page 11
.224-7", 8", 9", 12"	barrel blank polygon.....	page 13
.270-11" (6,8 Rem. SPC)	custom made barrel.....	page 16
.408-13"	"Big bull"	page 19
8,557IS / 9,3x62	Match barrel finished	
	for M1-Garand	page 20

The legendary BISLEY VICE

Originally designed for gunsmiths, the **BISLEY VICE** proved to be a very good solution for a wide range of applications for nearly all kinds of craftsmanship:



- mountable within seconds on all types of tables without tools
- rapidly lockable
- for firearms cleaning: stressing via cork jaws
- stressing of other parts: via steel jaws
- revolving and clamp able at any angular position
- handy and transportable (only 1.8 kg)

What can we do for you?**Deep Hole Drilling**

We can do deep hole drilling diameters 3mm to 20 mm with a max. length of 1000 mm.

CNC-Machining

We are specialist in turning and milling long (up to 1000 mm) and thin parts.

Reaming / Honing

With our special honing and reaming machines we achieve the best possible inside surface qualities ($R_z < 1$), from the inside diameter 3 mm to 20 mm and lengths up to 750 mm.

Straightening of long parts

We have experience in straightening long shafts and tubes of any kind with diameters up to 80 mm and lengths over 1500 mm.

Precision steel tubes

We can provide you with various dimensions and materials from our inventory. Cut to length and machined to your specifications.

Article-No. 600

Barrel Blanks for smokeless powder made from special rifle steel

calibre	external diameter mm	length mm	EUR/pcs.
4 mm M 20 /No. 7	10	474	A
	15	474	A
	23	330	B
4 mm No. 12	24	330	B
5,6x50 Mag./R Mag.	10	755	B
	17	620	B
	23	650	C
	23	755	D
	26	650	D
	26	755	D
	30	605	D
	30	655	D
5,45x39,5	30	655	D
5,6x52 R	12	690	B
	23	650	C
	23	755	D
	30	655	D
5,6x57/5,6x57 R	17	620	B
	23	650	C
	26	650	D
	30	605	D
	30	655	D
6XC	NEW	32	665
6 mm Flobert	15	470	A
6 mm Rem. (.243-9")	30/32	655/665	D
6 mm PPC (.243-14")	30/32	655/665	D
6 PPC USA	30	655	D
6 mm Norma BR (.243-8")	30/32	655/665	D
	32	765	F
6x70 R (.243-10")	30/32	655/665	D
6x62 Freres	30	605	D
	30	655	D
6,35 mm (.25 ACP)	12	530	B
	26	195	B
	26	595	D
6,5x47 Lapua (.264-8")	32	665	C
6,5x53 R Mannl./6,5x54 M.-Sch.	30	655	D
6,5x54 Mauser	30	655	D
6,5x55 Schwed.	30	605	D
	30	655	D
	30	744	E
6,5x57/57 R/6,5x65/65 R	30	655	D
6,5x68/68 R	30	655	D

*) see separate price sheet, please inquire for your price and dealer discount

Article-No. 600

Barrel Blanks for smokeless powder made from special rifle steel

calibre	external diameter mm	length mm	EUR/pcs.
7,65 mm Browning (.32 ACP)	14	590	B
/7,65 Para / 7,63 Mauser	17	590	B
	26	195	B
	26	595	D
7x49 GJW	30	385	C
7x57/57 R/7x64/65 R	26	725	D
	30	605	D
	30	655	D
	30	744	E
	32	665	D
7x66 SE vom Hofe	30	655	D
7mm Rem. Mag./7mm Rem 08/7mm STW	32	655/665	D
7mm Weath. Mag. (.284-10")	30/32	655/665	D
7,5x55 Swiss Ord. GP 31	30	655	D
	30	800	E
7,62x25 Tokarev /7,62x39			
/7,62x54 R M.-Nagant.	30	655	D
7,65x53 Arg.	30	744	E
7,65x53 Arg.	30	744	E
8,15x46 R	22 mm, octagon shape	750	F
8,15x46 R	25 mm, octagon shape	750	F
	23	820	D
	30	605	D
	30	744	E
8x33	30	655	D
8x57 IS/8x57 IRS/8x64 S	26	705/725	D
	30	605	D
	30	655	D
	30	744	E
	(8mm - 10")	32	665
8x68 S	32	665	D
8,5x63 (.338-10")	30	605	D
	30	655	D
9mm Flobert (shot)	23	655	C
9mm kurz (.380 ACP)	18	620	B
	21	610	C
	30	235	B
	32	605	D
	38/42	216	B
	38/42	216	D

*) see separate price sheet, please inquire for your price and dealer discount

more barrel blanks, see page 15 "Custom Made"

Article-No. 600

Barrel Blanks for smokeless powder
made from **special rifle steel**

calibre	external diameter mm	length mm	EUR/pcs.
9 mm Para (Luger)	18	620	B
(twist 250 mm)	21	610	C
.	30	235	B
.	30	470	C
.	32	665	D
.	38/42	216	B
.	38/42	435	D
9 mm Para for lead target bullets	18	620	B
(twist 416 mm)	21	610	C
.	30	235	B
9 mm Makarov	30	655	D
9x57	30	655	D
9,3x57/9,3x62/9,3x64/9,3x74 R	30	605	D
.	30	655	D
.	30	744	E
.	32	665	E
9,3x72 R	30	744	E
9,5x66 S.E. v. Hofe	30	655	D
10 mm Auto	38/42	435	D
10,3x60 R	30	705	D
10,75x68/10,75x73 (.404 Riml. N.E.)	30/32	655/665	D
12,7x70 Schüler	32	655	D
.17 Rem./ .17 HMR/.17 Mach 2	10	690	C
.	26	710	D
.	30	655	E
.204 Ruger 12" (10")	32	665	D
.22 smooth	12	590	B
.22 l.r. for standard rifle	10	755	B
.	12	470	A
.	12	690	B
.	15	470	A
.	15	620	B
.	16	540	B
.	17	620	B
.	18	610	B
.	23	650	C
.	23	755	D
.	26	650	D
.	26	755	D
.	30	755	E
22 mm octagon shape		755	F
.22 short for rapid fire pistol .	23	305	B
.22 l.r. for free pistol	23	305	B
.22 l.r. for standard pistol . . .	23	305	B
.22 l.r. for biathlon rifle	23	605	C
.	26	648	D

more barrel blanks, see page 15 "Custom Made"

*) see separate price sheet, please inquire for your price and dealer discount

Article-No. 600

Barrel Blanks for smokeless powder
made from **special rifle steel**

calibre	external diameter mm	length mm	EUR/pcs.
.22 Mag.	10	430	A
.	10	755	B
.	12	605	B
.	15	490	A
.	15	615	B
.	17	470	B
.	17	615	B
.	23	650	C
.	23	755	D
.	26	650	D
.	26	755	D
.22 Hornet	10	755	B
.	12	655	B
.	17	620	B
.	23	650	C
.	23	755	D
.	26	650	D
.	26	755	D
.	30	655	D
.22-250 Rem./ .220 Swift/ .224 Weath. Mag./ .225 Win.	17	620	B
.	23	650	C
.	26	650	D
.	30	605	D
.	30	655	D
.222 Rem./Rem.Mag(Drall 320 mm)	10	755	B
.	17	620	B
.	23	650	C
.	23	755	D
.	26	650	D
.	26	755	D
.	30	605	D
.	30	655	D
.223 Rem. (Kurzdral 178 mm=7")	32	665	D
.223 Rem. (Drall 305 mm=12")	10	755	B
.	17	620	B
.	23	650	C
.	23	755	D
.	26	650	D
.	26	755	D
.	30	605	D
.	30	655	D
.243 Win.	30	605	D
.	30	655	D
.25-06	30	655	D
.257 Roberts / .25 Rem.	30	655	D
.257 Weath. Mag.	30	655	D
.270 Win./Weath. Mag	30	655	D
.280 Rem.	30	655	D
.30 Carbine	17	590	B
.	30	655	D

more barrel blanks, see page 15 "Custom Made"

*) see separate price sheet, please inquire for your price and dealer discount

Article-No. 600

Barrel Blanks for smokeless powder
made from **special rifle steel**

calibre	external diameter mm	length mm	EUR/pcs.
.32 S & W long f. revolver ..	17	590	B
.32 S & W long f. revolver ..	23	285	B
.32 S & W long f. pistol ..	23	285	B
.308 Win. / .30 R Blaser /	30	605	D
.300 Savage / .30-30 Win	30	655	D
.....	30	744	E
.....	32	766	F
.30-06 / .308 Norma Mag. /	30	605	D
.300 Win. Mag. / .300 Weath. Mag.	30	655	D
.300 H + H Mag.	30	655	D
.....	30	744	E
.....	32	665	F
.303 British	32	665	D
.318 WR	30	655	D
.338 Win. Mag. / .338 Lapua Mag.	30/32	655/665	D
.340 Weath. Mag.	30	655	D
.....	30	655	D
.....	30	655	D
.35 Wheelen	18	620	B
.38 Spec. / .357 Mag.	21	610	B
.....	30	235	C
.....	30	470	C
.....	32	665	D
.....	42	216	B
.....	42	435	D
.38-40	32	665	D
.38 Super Auto / .357 SIG ..	23	285	B
.38-55 twist 16" (.379-16") ..	32	665	B
.38-55 twist 16" (.379-16") ..	32	915	F
.375 H & H Mag. / .375 Win.	30	605	D
.....	30	655	D
.375 WR / .378 Weath. Mag.	30	655	D
.40 S & W	26	285	B
.....	38/42	216	B
.....	38/42	435	D
.404 Riml. N. E. (10,75x68/ 10,75x73) ...	30/32	655/665	D
.416 Rigby	30/32	655/665	D
.416 Weath. Mag. / Rem. Mag.	30/32	655/665	D
.41 Action Express	38/42	285	B
.425 WR	32	665	D
.44 Rem. Mag / .44 Colt. ...	23	590	C
.....	26	650	D
.....	30	605	D
.44-40 twist 20"	32	665	D
.444 Marlin	30	655	D
.45 Colt / .45 ACP	26	285	B
.....	26	585	B
.....	42	216	B
.....	42	435	D
.45-70	30	755	E
.45-70	32	900	F
.458 Win. Mag/.45 Blaser ..	32	665	D
.460 Weath. Mag.	30	655	D
.470 Nitro Express	32	665	D
.50 A.E.	42	435	D
.500 Nitro Express	32	665	D
.50 BMG (12,7x99)twist 381mm	42	915	G
.50 BMG (12,7x99)twist 250mm	42	915	G
.50 Sharps twist 10"	32	715	E
.50 Sharps twist 26"	32	915	F
.505 Mag. Gibbs	32	665	D
.577/450	30/32	850	E
.577 N.E.	30/32	655	D
.585 Nyatti	32	665	D

more barrel blanks, see page 16 "Custom Made"

*) see separate price sheet, please inquire for your price and dealer discount

Article-No. 660

Stainless Steel Barrel Blanks
for **smokeless powder**

calibre	external diameter mm	length mm	EUR/pcs.
5,6x50 Mag. / R Mag.	10	755	D
.....	23	725	E
.....	32	655	F
5,6x57	32	655	F
5,6x52 R	10	755	D
5,6x52 R	23	725	E
5,6x52 R	32	655	F
6XC	32	715	G
6 mm PPC (.243-14")	32	655	F
6 mm Norma BR (.243-8") ..	32	655	F
6 mm Norma BR (.243-8") ..	32	765	G
6x70 R	23	655	E
6x70 R	23	725	F
6,5x47 Lapua (.264-8")	32	665	F
6,5x55 Schwed.	32	655	F
6,5-284 F-Class Spec. twist 8,5" .	32	715	G
7mm Rem. Mag/7mm 08/7mm STW	32	655	F
7x57 / 57R / 7x64 / 65R ..	32	655	F
7,5x55 Swiss Ord.	32	655	F
7,65 mm = .32 ACP / 7,65 Para	18/23	605	D
8x57 IS / IRS / 8x64 S	32	655	F
8x68 S	32	655	F
9 mm short = .380.	18/23	605	D
9 mm short = .380.	30	185	B
9 mm Para = 9 mm Luger ...	23	605	D
9 mm Para = 9 mm Luger ...	32	185	B
9 mm Para = 9 mm Luger ...	32	665	F
9 mm Para = 9 mm Luger ...	42	435	F
9,3x62 / 64 / 74	32	655	F
10 mm Auto	42	435	F
.17 Rem. / .17 HMR	23	725	E
.17 Rem. / .17 HMR	26	655	E
.17 Rem. / .17 HMR	32	665	F
.204 Ruger (10" or 12")	32	665	F
.22 l.r. (stainless rifle tube) ..	10	755	D
.22 l.r. (stainless rifle tube) ..	12	755	D
.22 l.r.	23	665	D
.22 l.r.	26	475	C
.22 l.r.	32	665	F
.22 Mag. (stainless rifle tube)	12	755	D
.22 Hornet (stainless rifle tube)	10/12	755	D
.22 Hornet	23	725	E
.22 Hornet	32	655	F
.22-250 Rem. / .220 Swift / (.224-14")	32	655	F
.224 Weath. Mag. / .225 Win.	32	655	F
.222 Rem. / Rem. Mag.	10	755	D
.222 Rem. / Rem. Mag.	23	725	E
.222 Rem. / Rem. Mag.	32	655	E
.223 Rem.	23	725	F
.223 Rem. (.224-12")	32	665	F
.243 Win. (.243-10")	32	655	F
.270 Win.	32	665	F
.30 Palma 13" twist	32	775	G
.308 Win. / .30 R Blaser /	32	655	F
.300 Savage / .30-30 Win.	32	655	F
.30-06 / .300 Weath. Mag. / .308 Norma Mag. /	32	655	F
.300 Win. Mag./ .300 H&H Mag.	32	655	F
.338 Win. Mag. (8,5x63) ..	32	655	F

more stainless barrel blanks, see page 16 "Custom Made"

*) see separate price sheet, please inquire for your price and dealer discount

Barrel Blanks		Article-No. 660		Stainless Steel	
for smokeless powder					
calibre	external diameter mm	length mm	EUR/pcs.		
38 Spec./ .357 Mag.	18/23	605	D	more blanks see page 15	
.....	32	185	B		
.....	32	665	F		
.375 H & H Mag.	32	655	F		
.40 S & W	42	435	F		
.44 Rem. Mag. / .44 Colt	32	435	D		
.....	32	665	F		
.454 Casull	42	435	F		
.404 Riml. N. E.	32	665	F		
(10,75x68/ 10,75x73)	32	665	F		
.45 ACP / .45 Colt	42	435	F		
.....	42	655	F		
.458 Win. Mag.	32	655	F		
.50 BMG	42	915	I		

Barrel Blanks for black powder		Article-No. 640		made from special rifle steel	
cold drawn material octagon shape					
calibre	external dimension mm	twist mm	length mm	EUR/pcs.	
8 mm	22	450	285	B	
.31	20	450	250	B	
.31	22	450	285	C	
.36	22 / 25	450	285	C	
.38	22	450	285	C	
.38	25	1200	850	F	
.38	28	1200	850	F	
.41	22	450	285	C	
.41	25	1200	850	F	
.44	22 / 25	450	285	C	
.45	22 / 25	450	285	C	
.45	25	1200	850	F	
.45	28	1200	750/850	F	
.45	22 / 25	1200	1000	F	
.54	25 / 28	1200	850	F	
.58	28	1200	850	F	
Especially designed for long bullets (designated N5/N7)					
.38N5	25	508	850	F	
.38N7	25	710	850	F	
.38N7	28	710	850	F	
.45N7	25	710	850	F	
.45N7	28	710	850	F	
round material					
calibre	external diameter mm	twist mm	length mm	EUR/pcs.*	
.31	Ø 23	450	435	B	
.36	Ø 23	450	435	B	
.36	Ø 38	450	435	D	
.38	Ø 32	1200	850	E	
.44	Ø 22	450	220	B	
.44	Ø 22	450	285	B	
.44	Ø 25	450	285	B	
.45	Ø 32	1200	850	E	
.54	Ø 26	450	565	D	
.54	Ø 32	1200	850	E	
.58	Ø 32	1200	850	E	
Especially designed for long bullets (designated N7)					
.38N7	Ø 32	710	850	E	
.45N7	Ø 32	710	850	E	
Individual profiles or twists available on demand					

*) see separate price sheet, please inquire for your price and dealer discount

Barrel blanks for Air Gun		Article-No. 780		made from special rifle steel tubes	
standard profile:					
calibre	external diameter mm	length mm	EUR/pcs.*		
4,5 (.177)	9/10/12				
.....	13/14/15/16	605	B		
5,0 (.20)	12/15/16	605	B		
5,5 (.22)	10/12/15/16/17	605	B		
6,35 (.25)	12/15/16	605	B		
polygon profile:					
4,5 Polygon	12/16	605	B		
5,5 Polygon	16	605	B		
6,35 Polygon	16	605	B		
other dimensions and choke on request.					

Barrel Blanks with polygon profile		Article-No. 620		special rifle steel	
for pistol and revolver					
cal.	twist	Ø mm	length	EUR/pcs.*	
cal. 9 mm Para	twist 250/.....	18	620	B	
.38 Spez./ .357 Mag.	twist 450...	30	235	B	
.....	32	605	E	
.....	42	435	D	
cal. 10 mm Auto	26	285	B	
.....	42	435	D	
cal. .40 S & W	26	285	B	
cal. .44 Mag.	42	435	D	
cal. .45 ACP	26	285	B	
.....	42	435	D	
for rifles					
cal. .308	30	655	D	
cal. .30-06	30	655	D	
cal. .223 Rem (.224-7",8",9",12" NEW)	30	655	D	

stainless.**Article No. 666**

for pistol and revolver		Ø mm	length	EUR/pcs.*	
cal. 9 mm Para	42	435	F	
cal. 10 mm Auto	42	435	F	
cal. .38 / .357	42	435	F	
cal. 40 S & W	42	435	F	
cal. 45 ACP	42	435	F	
for rifles					
cal. .308 Win.	32	655	F	
cal. .30-06	32	655	F	
cal. .223 Rem (.224-7",8",9",12" NEW)	32	655	F	

*) see separate price sheet, please inquire for your price and dealer discount

Custom made Gun Barrels

You can choose calibre, twist, contour, chamber, thread and muzzle available contours

#1100 Feather Weight Sporter



#1200 Light Weight Sporter

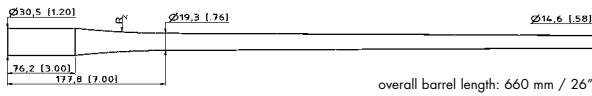

#1300 Standard Sporter



#1400 Heavy Weight Sporter

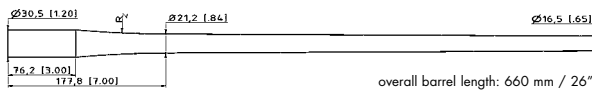

#1450 Super-Magnum Sporter

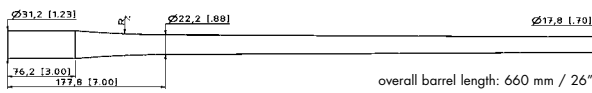

#1500 Bavarian Classic



#2100 Light Weight Varmint

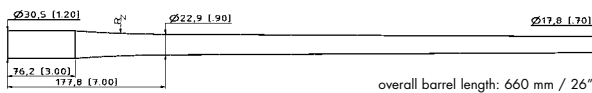

#2200 Medium Weight Varmint

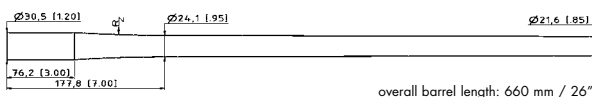

#2230 Heavy Sporter Varmint

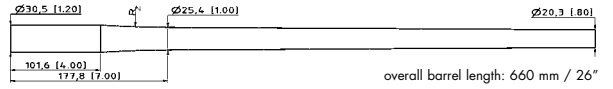

#2260 Remington Varmint

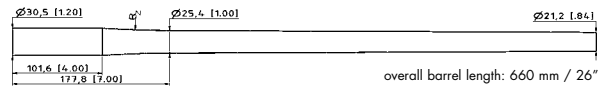

#2300 Bench Rest Light Varmint

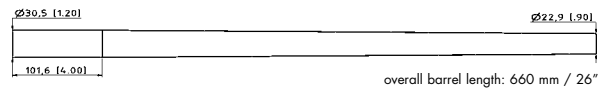

#2340 Medium Target Varmint

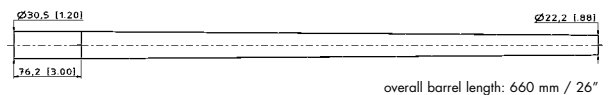

#2400 Standard Heavy Varmint

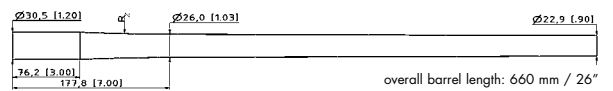

#2500 Bench Rest Heavy Varmint

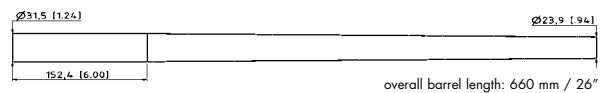

#3100 Light Weight Target

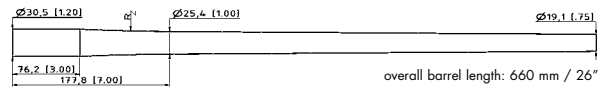

#3150 Hunter Class Target



*] see separate price sheet, please inquire for your price and dealer discount

*] see separate price sheet, please inquire for your price and dealer discount

#3200 Heavy Weight Target

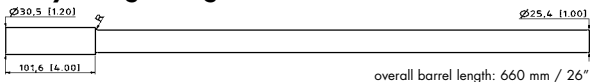

#3250 Heavy Bull Target

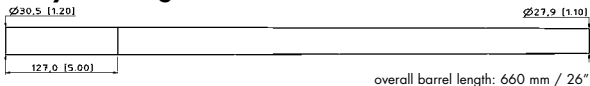

#3300 Straight Target

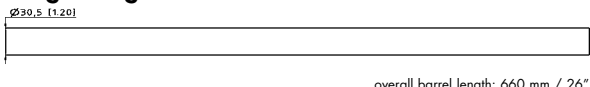

#3400 Muzzle Weight Match Target

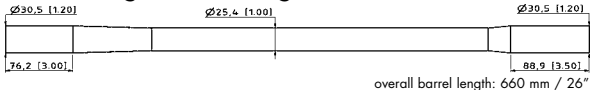

barrel blank Ø 32 mm L = 665 mm
special rifle steel or stainless steel

calibre	twist
.17	9", 10", 12"
.22 Rimfire	16"
.204 Ruger	10", 12"
.224	7", 8", 9", 10", 12", 14"
.243/6 mm	8", 9", 10", 14"
.25	10"
.264/6,5 mm	8", 9", 10"
.270	10", 11" (6,8 Rem. SPC)
.284/7 mm	9", 10", 12"
.30	8", 10", 11", 12", 14"
.312	16"
8 mm	10"
.338	10"
.358	12"
9,3 mm	12"
.375	12"
.379	16"
.416	14"
.423	14"
.428	20"
.458	14", 18"
.510	10"

Prices	EUR/pcs.*
barrel blank (665 mm)	D
barrel blank (715 mm)	E (not all calibres)
barrel blank stainless steel (665 mm)	F
barrel blank stainless steel (715 mm)	E+A
barrel blank stainless steel (813 mm)	F+A (.30-10",-12";.243-8";.264-8",9")
costs for contour	Z3
thread (System 98, Sako etc.)	Z3
special thread	please inquire
chamber	Z6
muzzle	Z2 (Match, ballig, 11° Varmint)
fluting	F
special match treatment	Z6

*) see separate price sheet, please inquire for your price and dealer discount

Rifle Barrels finished in the white
hunting contours for Mauser 98 action

#718 light NEW

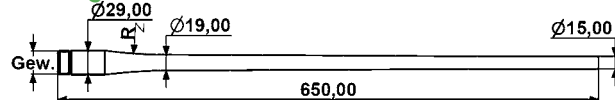

#720

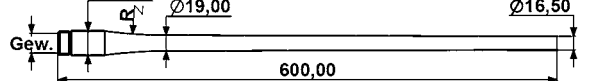

#722

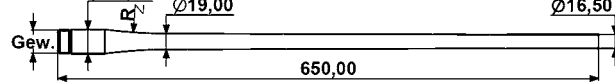

#724

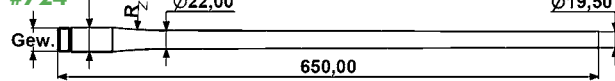

calibre	#718		#720		#722		#724	
	N	R	N	R	N	R	N	R
6,5x55	o	o	•	o	•	o	•	o
6,5x57	o	-	o	-	o	-	o	-
6,5x65	o	-	o	-	•	-	o	-
6,5x68	o	-	o	-	•	-	o	-
7x57 (7mm Mauser)	o	o	•	o	•	o	o	o
7x64	•	o	•	o	•	o	o	o
7mm Rem Mag.	o	o	o	o	•	o	o	o
7mm Rem 08	o	o	o	o	•	o	o	o
7,5x55	o	o	o	o	o	o	o	o
8x57IS (8mm Mauser)	•	o	•	o	•	o	o	o
8x68S	o	o	o	o	•	o	•	o
9,3x57	o	o	o	o	o	o	•	o
9,3x62	•	o	•	o	•	•	•	o
9,3x64	o	o	•	o	•	o	•	o
12,7x70 Schüler	-	-	-	-	-	-	•*	-
.22-250 Rem.	o	o	•	o	•	o	o	o
.222 Rem.	o	o	•	o	o	o	o	o
.223 Rem.	o	o	•	o	o	o	o	o
.25-06 Rem.	o	o	o	o	•	o	o	o
.243 Win.	o	o	•	o	o	o	o	o
.270 Win.	o	o	•	o	•	o	o	o
.308 Win.	o	o	•	o	•	o	•	•
.30-06	•	o	•	o	•	•	o	o
.300 Win. Mag.	o	o	o	o	•	o	•	o
.300 H&H Mag.	o	o	o	o	•	o	o	o
.300 Weath. Mag.	o	o	o	o	•	o	o	o
.338 Win. Mag.	o	o	o	o	•	o	•	o
.375 H&H Mag.	o	o	o	o	•	o	o	o
.404 Rimles N.E.	o	o	o	o	o	o	•	o
.416 Rigby	o	o	o	o	o	o	•	o
.416 Rem. Mag.	o	-	o	-	o	-	•	-
.458 Win. Mag.	o	o	o	o	o	o	•	o
.500 N.E.	o	-	o	-	o	-	•	-

N = special rifle steel (34 CrNiMo6) price E
R = stainless steel (X20Cr13) price G
 * = conical shape
 • = in stock, ready to ship
 o = possible item at extra cost price E+C / G+C
 - = not available
options: other threads (Sako/Rem./Win etc.) possible at additional cost
 other caliber (see stock list page 5-15) possible at additional cost

*) see separate price sheet, please inquire for your price and dealer discount

Lothar Walther Octagonal form

SWA width between flats	length	Art.-No.	EUR
14 mm	600 mm	7614	price please inquire
16 mm	650 mm	7616	
18 mm	650 mm	7618	

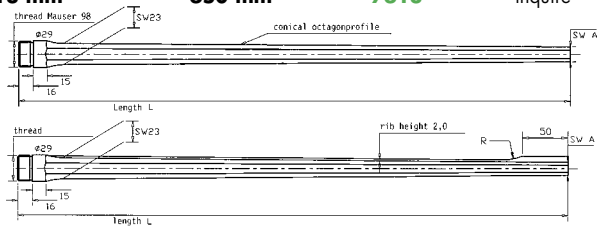

Tailored-made designs and special calibres possible. Please inform us about calibres and quantities and give us a drawing of the barrels external shape. You will then receive our detailed quotation.

Rifled Barrels Finished in the White for Combined Guns (without chamber) Art.-No. 740

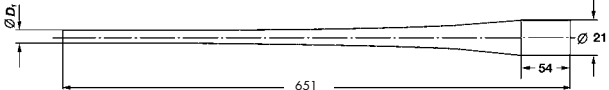

D1 = 10,5mm	6,5 x 57 R	D1 = 11,00mm	D1 = 13 mm
.22 Hornet	7 x 57 R / 7 x 65 R	8 x 57 IRS	9,3 x 74 R
5,6 x 50 R Mag.	.308 Win./ .30 R Blaser	8 x 75 RS	
5,6 x 57 R	30-06		
6 x 70 R			

Tailored-made designs and special calibres possible. Please inform us about calibres and quantities and give us a drawing of the barrels external shape. You will then receive our detailed quotation.

Finished Barrels in Special Contours

for Mauser 98 K action, **original Mauser step shape**

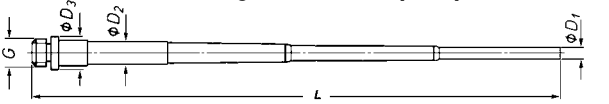

∅ D1 = 15,5mm, ∅ D2 = 23mm, ∅ D3 = 28,3mm, G = 1,1" x 12 TPI 55°

L = 600 mm Art.-No. 726 EUR/pcs.* E

6,5x57	8x33	.308 Win.	.300 Savage
7x57/7x64	8x57 IS	.243 Win.	.30-06

for Mauser rifle model 98, **original Mauser step shape**

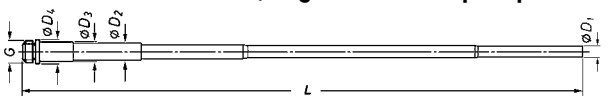

∅ D1 = 15,5mm, ∅ D2 = 23mm, ∅ D3 = 25mm, ∅ D4 = 28,5 mm
G = 1,1" x 12 TPI 55°

L = 740 mm Art.-No. 728 EUR/pcs.* F

8 x 57 IS = 8 mm Mauser .308 Win. 6,5 x 55

for rifle **original Wehrmann-contour**

∅ D1 = 15,4 mm, ∅ D4 = 28,1 mm, G = 1,1" x 12 TPI 55°

L = 742 mm Art.-No. 730 EUR/pcs.* F

calibre 8,15 x 46 R

for rifle **Carl Gustav model 96 original Swedish Mauser step shape**

∅ D1 = 15,5; D2 = 24,5; D4 = 28; Gewinde = 0,980"-12 G

L = 739 mm, calibre = 6,5x55 Art.-No. 729 EUR/pcs.* F

other calibre possible (additional costs C)

Finished Barrels for

Original Mauser Argentino , length 740 mm	Art.-No. 732	EUR* F
calibre 7,65 Arg.		
Gewehr 88 , length 740 mm	Art.-No. 734	EUR* F
calibre 8 x 57 JS		

LOTHAR WALTHER-match barrel

from **special rifle steel** or **stainless steel**
cal. 6mm Norma BR / 6,5x55 SM / 8x57 JS / .222 / .308

LW match barrel - „mündungsverstärkt“ (muzzle weight contour)
(for System 98, other calibres and threads are available on request)

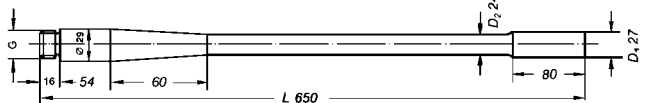

Art.-No. 750	special rifle steel	EUR/pcs* G
Art.-No. 7505	stainless steel	EUR/pcs* G

LW match barrel - „Birnenform“ (conical contour)

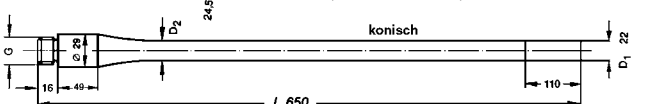

Art.-No. 752	special rifle steel	EUR/pcs* G
Art.-No. 7520	stainless steel	EUR/pcs* G

LOTHAR WALTHER Match Barrel „Palma“

made from **STAINLESS STEEL** - Cal. 308 Win. with special tight land and groove dimensions and 13" (330mm) twist without chamber

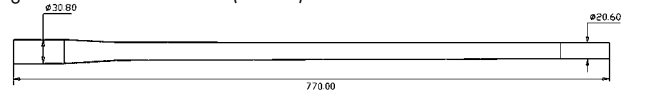

Art.-No. 7545	EUR/pcs* I
---------------	------------

„Big bull“ stainless barrel

calibre	twist	stainless steel, turned to
.224 (5,56 mm)	7" 8" 9"	∅ 1.45" (36,80 mm) and
.243 (6 mm)	8" 9" 10" 14"	length = 32" (815 mm) without
.264 (6,5 mm)	8" 9"	chamber or on request turned to a
.284 (7 mm)	9" 10"	contour of your choice.
.30 (7,62 mm)	9" 10" 12"	
.338 (8,5 mm)	10"	
.408	13"	

Art.-No. 7565 EUR/pcs* I

Rifle Barrel

finished for **AR-15 sporting rifle** (stainless steel)



cal. 223 Rem. twist 7", 8", 9"	Art.-No. 6200	EUR/pcs* H8
--------------------------------	---------------	-------------

Ruger 10/22® target barrel

stainless steel, finished in the white including extractor and locking cut diameter ∅ .920" (23,37 mm). Length L = 21,5" (546,1 mm)

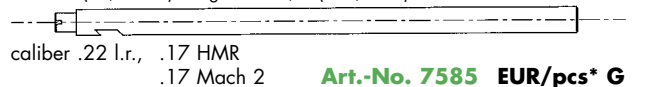

caliber .22 I.r., .17 HMR	Art.-No. 7585	EUR/pcs* G
.17 Mach 2		

*) see separate price sheet, please inquire for your price and dealer discount

*) see separate price sheet, please inquire for your price and dealer discount

LOTHAR WALTHER pistol barrels für Luger 08 finished in the white (without chamber)
(thread length: 19 mm) - Calibre 9 mm Para

available models: **EUR/pcs.***

Standard length 100 mm **E**

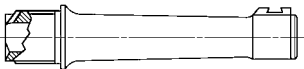

Standard long length 150 mm **F**

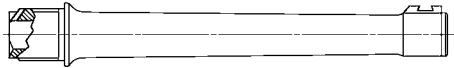

Marine length 150 mm **F**

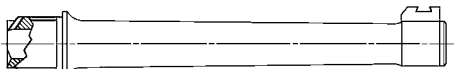

Artillerie length 200 mm **on request**



Match Barrel finished, for M1-Garand, NEW Original- and Match contour

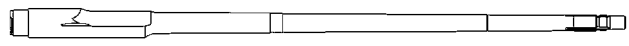

calibre .30-06, .308Win, 7x64, 8x57JS and 9,3x62
only scaled discount poss. **price I**

Barrel Blank for Shotgun **EUR/pcs* D**
for shotgun gauge 12, 16 und 20 (full- and half-choke available)

Barrel Blank for Shotgun price on request

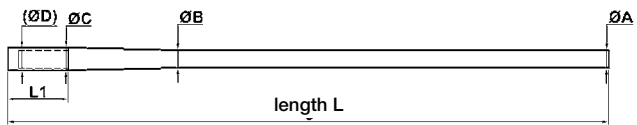

external diameters and lengths can be specified

*) see separate price sheet, please inquire for your price and dealer discount

additional services in special- and single production

chamber cal. 4mm - .22 Mag.	Z4
chamber for pistol/revolver	Z5
chamber for rifles	Z6
shorten of barrel blanks/finished barrels	on inquiry
special match treatment (for finished barrels possible only)	Z6
special twist	on inquiry
turning according drawing	on inquiry
fluting	F
standart threads 98, Sako	Z3
special threads	on inquiry

please send in sample of barrels or actions dismantled only.

Small Bore Practice Target **Article-No. 95**
for shooting with barrel inserts



14 x 14 cm (approx. 5 1/2" square) to fit air rifle pellet trap, range 5 meters.
The version of the target for Olympic Rapid Fire Pistol Events provides realistic practice conditions (after testing, mark aiming point with white patch.)
(100 pcs. per pack) **EUR/pack* Z2**

Barrel Warranty

The firm of LOTHAR WALTHER Precision Tool Manufacture GmbH, 89551 Königsbrunn, Germany hereby warrants that its gun barrels and gun barrel blanks have been manufactured in accordance with the relevant guidelines on the Firearms Act and have left our premises in perfect condition.

After assembly, each barrel, in conjunction with the statutory regulations in Germany, the regulations laid down for testing gun barrels (CIP standard), must be presented to a Firearms Office for testing and the initial firing, which must be carried out there. In countries which do not have similar regulations or which do not belong to the CIP, the testing and initial firing must be carried out in accordance with the principles of the German and CIP regulations. A copy of these are available upon request.

Following the above mentioned testing, only newly manufactured ammunition may be used and no guarantee can be accepted for hand-loaded, reloaded or re-manufactured ammunition. This includes surplus ammunition or any ammunition that contains defects, known or unknown. Furthermore, the barrel must be kept clean at all times.

Any alterations made to the barrel after manufacture shall void our manufacturer's warranty. We should emphasize that any gun is a dangerous weapon and should consequently be handled with care. The user and those nearby must take the appropriate measures to ensure that others can never be put at risk. This naturally includes protection for eyes and ears. Guns should never be pointed, aimed or fired at people. Representations made by persons other than the manufacturer do not constitute a part of this guarantee.

Since some gun barrels are designed for a particular purpose, the use of these barrels for a purpose different than originally intended could cause an unsafe situation. Before using any gun barrels for a different purpose, the manufacturer must be consulted as to its safe use.

Should a defect occur nevertheless, the barrel must be returned to the manufacturer, postage prepaid. The liability of the manufacturer is limited only to the replacement or repair of the barrel and is at its discretion.

LOTHAR WALTHER Feinwerkzeugbau GmbH

Direction of fire: big chamber is the chamber side

Warning! Safety Instructions!

Safety regulations for the use and handling of LOTHAR WALTHER products. Observe that the safety regulations that apply for the use of barrel inserts, adapters for shots and rifles, pistols and revolvers and crossbows, are exactly the same as those that apply for the use of original weapons loaded with original ammunition. They are not to be used for aiming at or shooting at human beings.

All products manufactured by LOTHAR WALTHER are to be used solely and exclusively for hunting activities or at specific and approved shooting stands. Firing and handling of any LOTHAR WALTHER products, whose use is restricted exclusively to shooting stands, is to be accomplished with utmost caution and care and not to take place anywhere else other than the approved shooting stands.

Any products which are intended for hunting are only to be used for hunting activities. Again, every precaution, care and safety measure must be taken, so that no human being can come to harm at any time.

*) see separate price sheet, please inquire for your price and dealer discount

Improve your skill with inexpensive small calibre ammunition by use of **BARREL Adapters**

In just a few minutes, and without tools, a gun can be converted into a smaller calibre, which enables it to be used both indoors and outdoors for training or plinking with less expensive ammunition.

Article-No. 470



Calibre 4 mm M 20 Centerfire Barrel Adapter

Available for all revolvers

Cal.: .32 S & W Long .44 Magnum
 .38 S & W .45 Colt
 .38 Spec. / .357 Mag.

attention: with barrel insert built in,
 never use original ammunition

add. auxiliary cartridge EUR* Z2

The insert comes with six auxiliary cartridges, ejector rod and cleaning brush.

EUR* Z7

When ordering, please state pistol or revolver model, calibre, barrel length and article no.

Article-No. 2172



Revolver Barrel Adapter Cal. .22 l. r. or .22 short Rimfire

With six insert shells, spanner, ejector rod, hook, cleaning brush

cal. .22 l. r. in the calibres
 .38 Spec./ .357 Mag.
 .44 Magnum
 .45 Colt

cal. .22 short in calibre
 .38 S & W

attention: with barrel insert built in,
 never use original ammunition

add. auxiliary cartridge EUR* Z2

EUR* Z7

*) see separate price sheet, please inquire for your price and dealer discount

Article-No. 370



Calibre 4 mm M 20 Centerfire Barrel Adapter

Available for **all automatic pistols**
4 mm M 20 cartridges are centerfire, low velocity loads particularly suited for indoor target shooting and for indoor and outdoor plinking.
4 mm inserts are delivered with six **auxiliary cartridges**, ejector rod and cleaning brush for pistols.

calibres:
7,65 mm 9 x 18 Ultra 9mm Para (Luger)
7,65 mm Para 9 mm short .45 ACP

EUR* Z7

Article-No. 151



Pistol Barrel Adapter Cal. .22 short Rimfire

With six insert shells, ejector rod, cleaning brush
calibres: 9 mm Para (Luger), 9 x 18 Ultra, .45 ACP

EUR* Z7

attention: with barrel adapter built in, never use original ammunition
add. auxiliary cartridge EUR* Z2

When ordering, please state pistol or revolver model, calibre, barrel length and article no.

Article-No. 170



Pistol Barrel Adapter Cal. .22 l.r. Rimfire

With rimfire adapter (as firing transmission)
Single shot in the calibres:
9 mm Luger = (9 mm Para), 9 x 18 Ultra, .45 ACP

EUR* Z7

Article-No. 264



Pistol Barrel Adapter Cal. 7,65 mm Browning (.32 ACP) to .22 Short

To date .22 barrel adapters were available only for pistols of Cal. 9 mm or larger. Now with this adapter, pistols in Cal. 7,65 mm Browning, (.32 ACP) may be fired on ranges where only .22 or unjacketed lead bullets are permitted.
Single shot with rimfire adapter (as firing transmission).

EUR* Z7

attention: with barrel adapter built in, never use original ammunition
additional transducer to rimfire EUR* Z2

*) see separate price sheet, please inquire for your price and dealer discount

Article-No. 99

Adapters for Rifles

For shooting less powerful, inexpensive cartridges in guns chambered for high-performance cartridges. The less powerful cartridge is very useful for inexpensive practice, blinking and for taking small game which would be ruined when the high-velocity cartridge is used.



fires
Cal. **.22 I.r.**
in one of the following cal.



- 5,6 x 50 Mag.
- 5,6 x 50 R Mag.
- 5,6 x 52 R
- 5,6 x 57
- 5,6 x 57 R
- 5,6 x 61
- 5,6 x 61 R
- .220 Swift
- .22-250
- .221 Rem.
- .222 Rem.
- .222 Rem. Mag.
- .224 Weath. Mag.

fires
Cal. **.22 Mag.**
in one of the following cal.



- 5,6 x 50 Mag.
- 5,6 x 50 R Mag.
- 5,6 x 52 R
- 5,6 x 57
- 5,6 x 57 R
- 5,6 x 61
- 5,6 x 61 R
- .220 Swift
- .22-250
- .222 Rem.
- .222 Rem. Mag.
- .224 Weath. Mag.

fires
Cal. **.22 Hornet**
in one of the following cal.



- 5,6 x 50 R Mag.
- 5,6 x 52 R
- 5,6 x 57
- 5,6 x 57 R
- 5,6 x 61
- 5,6 x 61 R
- .220 Swift
- .22-250
- .224 Weath. Mag.



fires
Cal. **.765 mm** Browning
in one of the following cal.

- .30-06
- .30-30
- .300 Win. Mag.
- .300 Weath. Mag.
- .300 H & H Mag.
- .303 British
- .308 Win.
- 7,62 x 54 R Moisin-Nagant

fires
Cal. **.30 Carbine**
in one of the following cal.

- .30-30
- .300 Win. Mag.
- .300 Weath. Mag.
- .303 British
- .308 Win.
- .30R Blaser

fires
Cal. **.32 S & W long**
in one of the following cal.

- 8 x 57 IS
- 8 x 57 IRS

fires
Cal. **.32 H & R Mag.**
in one of the following cal.

- 8 x 57 IS
- 8 x 57 IRS

fires
Cal. **.45 Colt**
in one of the following cal.

- .460 Weath. Mag.

EUR* Z5

*) see separate price sheet, please inquire for your price and dealer discount

Article-No. 270



4 mm Adapters for Rifle Calibre

The insert, by virtue of its own self-contained barrel, enables the 4 mm M 20 centerfire cartridge to be fired from any rifle, and is manufactured for most of the German and International calibres from 5,6 x 50 R through to 10,75 x 68 and from .22 Hornet through to .600 N.E.

EUR* Z5

Article-No. 431



Rifle Barrel Adapter Cal. .22 I.r. Rimfire



With firing transmission, ejector rod, cleaning brush. For magazinerifles and combined rifles for target shooting. Range 10 meters.

- | | | |
|------------------------|------------|------------------|
| in the calibres: | 8 x 57 IS | .30 R Blaser |
| 7 x 57 | 8 x 57 IRS | .308 Win. |
| 7 x 64 | 8 x 68 S | .30-06 |
| 7 x 57 R | 9,3 x 62 | .300 Win. Mag. |
| 7 x 65 R | 9,3 x 64 | .300 Weath. Mag. |
| 7 mm Rem. Mag. | 9,3 x 72 R | .338 Win. Mag. |
| 7,5 x 55 Schweiz. Ord. | 9,3 x 74 R | .375 H & H Mag. |
| 7,62 x 54 R.M.N. | .270 Win. | .458 Win. Mag. |
| | | .500 N.E. |

EUR* Z5

Article-No. 2470

4 mm Calibre Shotgun Practice Unit



Shotgun practice indoor and outdoor. The shotgun practice target can be used. Range 5 meter.

Not for pump guns usable.

Calibre from bore (gauge) size
4 mm M 20 centerfire 12 16 20 36 (.410)

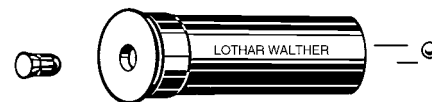

EUR* Z5

*) see separate price sheet, please inquire for your price and dealer discount

Despatcher for the Smaller Predators

A rifled barrel adapter, with a pelt preserving small calibre bullet, for the short-range despatch of smaller predators caught in snares or netting (burrow trapping). Can be carried in the pocket, like a cartridge, ready loaded for speedy chambering and discharge.

Article-No. 186

Shoots Cal. 6,35 mm from shotgun barrel 12 bore (gauge) 
 16 bore (gauge)
 20 bore (gauge)



EUR* Z5

Article-No. 185

or Cal. .22 l.r. from shotgun barrel 12 bore (gauge) 
 16 bore (gauge)
 20 bore (gauge)

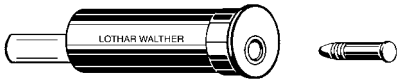

EUR* Z5

Article-No. 1851

or Cal. .22 Magnum from shotgun barrel 12 bore (gauge) 
 16 bore (gauge)
 20 bore (gauge)

EUR* Z5

Article-No. 184

or Cal. 6,35 mm from revolvers Cal. .38 Special/
 .357 Mag. 
 .44 Rem. Mag.
 .45 Colt



EUR* Z4

Article-No. 183

or Cal. .22 l.r. from revolvers Cal. .38 Special/
 .357 Mag. 
 .44 Rem. Mag.
 .45 Colt



EUR* Z4

Article-No. 182

Injured Game (Hoofed) Despatcher

For the speedy despatching of shot-injured hoofed game without carcass damage. Rifled barrel insert manufactured in

accordance with paragraph 19 of the Federal German Hunting Association Regulations. Shot dispersion 35 mm at 5 meters shooting distance. Can be carried in the pocket, like a cartridge, ready loaded for speedy chambering and discharge.

Shoots Cal. .38 Special
 from 12 bore (gauge)
 from 16 bore (gauge)
 from 20 bore (gauge)

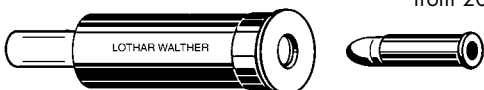

EUR* Z5

*) see separate price sheet, please inquire for your price and dealer discount

Adapters for Shotgun Article-No. 2370

For outdoor shotgun practice using empty tin cans either standing, rolled, thrown or swinging. The short safe range, 5 to 10 meters, causes no disturbance to hunting grounds. Also for pest control.

Calibre	from bore (gauge) size
6 mm with shot	12 16 20 28
6 mm double charge with shot .22 long shot	
9 mm with shot	12 16 20
9 mm double charge with shot	

EUR* Z5

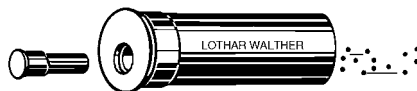



Adapters for Shotgun Article-No. 2570



cal. 12 to cal. 16/20/36 (.410) shot



cal. 16 to cal. 20/36/ (.410) shot



cal. 20 to cal. 36/ (.410) shot

shooting results in 12/16/20 are about the same as for the original size.

Cal. 12 to 16 to 20	to 36 (.410) Shot
Cal. 16..... to 20	to 36 (.410) Shot
Cal. 20.....	to 36 (.410) Shot

EUR* Z3

Dummy cartridge (for training purposes)

in calibre 9 mm Luger, .223 Rem

other calibres possible

*) see separate price sheet, please inquire for your price and dealer discount

Muzzle brakes



Rifle steel or **stainless** in different versions and sizes:
 thread: M15x1 or M18x1
 inner-diameter: 7,0 mm
 outer-diameter: 16,5 mm, 19,5 mm or 22,0 mm
 The final bore size has to be adjusted to the calibre

EUR* Z5

Article-No. 971

Snap Cap (German reg. patent) DBGM

buffer cartridge to protect the firing pin



for **shotgun** Cal.: 10 bore (gauge) 20 bore (gauge)
 12 bore (gauge) 28 bore (gauge)
 16 bore (gauge) 36 bore (gauge) (.410)

EUR* Z1



Article-No. 97

For rifle cal.:

5,6 x 50/R	7 mm Rem. Mag.	.22 l.r.	.30-30 Win.
5,6 x 52 R	7 mm Weath. Mag.	.22 Hornet	.30 R Blaser
5,6 x 57	7,5 x 55	.222 Rem.	.303 British
5,6 x 57 R	8 x 57 IS	.223 Rem.	.308 Win.
6 mm PPC	8 x 57 IR	.243 Win.	.30-06
6,5 x 55 SM	8 x 57 IRS	.257 Weath. Mag.	.338 Win. Mag.
6,5 x 57	8 x 68 S	.270 Weath. Mag.	.340 Weath. Mag.
6,5 x 57 R	8 x 75 RS	.270 Win.	.375 H & H Mag.
6,5 x 65 R	9,3 x 62	.280 Rem.	.375 Weath. Mag.
7 x 57	9,3 x 64	.300 Win. Mag.	.416 Rigby
7 x 57 R	9,3 x 72 R/74 R	.300 Weath. Mag.	.458 Win. Mag.
7 x 64	10,3 x 60 R	.300 H & H Mag.	.45-70
7 x 65 R		.470 N. E.	500/416 N.E

For pistol and revolver cal.:

	.22 l.r.	.32 S & W u. S & W long
	.22 Magnum	.357 SIG
	7,65 mm Browning	.38 Spec./357 Mag.
	9 mm Parabellum	.38 S & W
	9 mm kurz	.40 S & W
	10 mm Auto	.44 Rem. Mag.
	.45 ACP	.45 Colt
	454 Casull	50 AE

(other calibres available. minimum quantity 20 pieces.)

EUR* Z1

*) see separate price sheet, please inquire for your price and dealer discount

Shotgun Practice Target

Article-No. 94

for use in conjunction with 4 mm calibre shotgun practice barrel.
 14 x 14 cm (approx. 5 1/2 square) for air rifle pellet trap, range 5 meters.

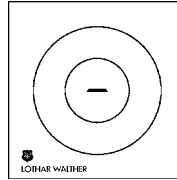

The aiming mark on this target shows a clay pigeon as seen from a distance of 35 meters.
 A direct hit is when the shot column hits the inner circle. If the shot column hits the outer circle, the pigeon would still be hit. A hit outside the circles is considered to be a miss.

(packed in a set of 100 pc.) **EUR* Z2**

Article-No. 980

SALUT-ADAPTER

for **shotgun**



calibre 12-16-20
 to calibre 9 mm Knall (.380)
 (packed in a set of 2 pc.)

EUR* Z2

Article-No. 31

Combined Spirit-Level Foresight with light-emitting diodes (German Reg. Patent)

This attachment enables the marksman to control his firing position - upright or canted - thus attaining maximum scores.

The spirit-level is integral with the foresight tunnel and oncentrally adjustable. The combined spirit-level foresight has been nationally and inter-nationally approved for small-bore free rifle, small-bore English Match and free rifle range 300 meters.

When ordering please state thread of foresight tunnel M 18x0,5 or M 17x0,5.



EUR* Z6

Article-No. 93

Inspection Lamp

A practical method of examining gun barrels (8 mm upwards) and cavities in general.

For shooters, hunters, handymen, modellers, tool-makers and many others.

Comes fully equipped for instant use with two leak-proof 1.5 volt batteries.

Delivered in **packs of 10 only** (to dealers)

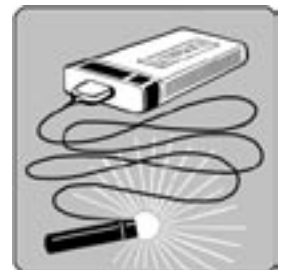

EUR* Z2

*) see separate price sheet, please inquire for your price and dealer discount

Leisure-Crossbow Hobby-Tell 2

with pin hole sight

10 and 5 metre
tension = 28 kg
or 3 metre
tension = 18 kg

recommended from
the German
rifle association

Art. 8000



incl. 1 arrow
and 2 targets

We recommend the spring loading lever, Item No. 8012, for spring loading the crossbow.

Warning:
for 10 m and 5 m: Use arrow with black tip only (No. 8011)
for 3 m: Use arrow with red tip only (No. 8061)

Tell-Targets



No. 9010
for 10 m

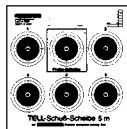

No. 9011
for 5 m and 3 m

Accessories and replacement parts EUR*

Hobby-Tell 2	8000	H7
arrow (with black tip -10m and 5 m)	8011	H1
spring loading lever	8012	H4
bow (10 or 5 m)	8013	H6
string	8014	H3
bow (3 m)	8060	H6
Tell targets 10 m (100 pcs.)	9010	H2
Tell targets 3 or 5 m (100 pcs.)	9011	H2
sight assembly (in front)	8020	H2
sight assembly (behind)	8021	H3
trigger (complete)	8025	H5

Warning! Safety Precautions:

Never point, aim or shoot the Hobby Tell crossbow at people or animals.
(Not a toy)

*) see separate price sheet, please inquire for your price and dealer discount

Sport-Crossbow Hobby-Tell 2 - SPORT

10 metre
tension
= 28 kg

NEW
with improved
diopter

recommended from
the German
rifle association

Article No.8080



incl. 1 arrow
and 2 targets

The crossbow is with airgun diopter and aperture front sight. So it's fantastic for beginners of the shooting sport. Also it's a alternative trainings equipment for airgun shooter.

Tell-Targets



No. 9010
for 10 m

Accessories and replacement parts EUR*

Hobby-Tell 2 - Sport	8080	H8
arrow (with black tip)	8011	H1
spring loading lever	8012	H4
bow (10 m)	8013	H6
string	8014	H3
Tell targets (10 m)	9010	H2
diopter	9090	H5
aperture front sight	8095	H4
trigger (complete)	8025	H5

Warning! Safety Precautions:

Never point, aim or shoot the Hobby Tell crossbow at people or animals.
(Not a toy)

*) see separate price sheet, please inquire for your price and dealer discount